

## User Manual and Installation Guide



**RAD-0102-6**

**Remote CO2 Storage Safety 3 Alarm**



**CO2METER**  
GAS MEASUREMENT SPECIALISTS

**CO2Meter**  
105 Runway Drive Ormond Beach, FL 32174 USA  
(877) 678-4259

Copyright © CO2Meter, Inc. All Rights Reserved.  
Revision 03.07

## **Warning!**

This product should only be used as described in this manual. If the equipment is used outside of the manner specified by CO2Meter, the protection provided by the equipment may be diminished.

This equipment should be installed/serviced by qualified personnel only.

Please contact [Support@CO2Meter.com](mailto:Support@CO2Meter.com) for more information.

# Contents

- General information on Carbon Dioxide Safety ..... 4**
- Introduction to the RAD-0102-6..... 5**
- Key Features..... 5**
- Display..... 6**
- Icons and Symbols ..... 6**
- Specifications..... 7**
- Layout ..... 8**
- SEU (Sensor Unit) ..... 9**
- RDU (Remote Display Unit) ..... 10**
- Strobes ..... 10**
- Power ..... 10**
- Installation ..... 11**
- Operation ..... 12**
- Start-up..... 12**
- Quick Test the System ..... 12**
- Unlocking/Locking Settings ..... 12**
- Configuring AL1..... 13**
- Configuring AL2..... 13**
- Configuring AL3..... 13**
- Latch ON/OFF (Default Latch is set to OFF) ..... 14**
- Reset Latch ..... 14**
- Baro ON/OFF (Default Baro is set to ON) ..... 15**
- Calibration ..... 16**
- System Test ..... 17**
- Factory Reset ..... 17**
- Maintenance..... 18**
- Error Codes..... 18**
- Warranty ..... 19**
- Product Returns..... 20**
- Support ..... 20**
  - Contact Us ..... 20**



# GENERAL INFORMATION ON Carbon Dioxide SAFETY

According to the **Occupational Health and Safety (OHS)** guidelines, carbon dioxide is a Class A, compressed gas. At low concentrations, the gas is not hazardous. However, as concentration levels increase, so do the severity of potential health effects. CO2 gas does not support life and in concentrations above 4% it has dangerous effects and negative implications. Health implications consist of headaches, fatigue, nausea, unconsciousness, and even fatality.

## PHYSICAL SYMPTOMS OF CO2 LEVELS



**0.1% | 1,000 PPM**

Prolonged exposure can affect concentration



**0.5% | 5,000 PPM**

The International Safety Limit (HSE, OSHA)



**1.0% | 10,000 PPM**

Rate of breathing increases slightly



**3.0% | 30,000 PPM**

An increase in heart rate, blood pressure, and headaches. Hearing can become impaired.



**10-100%**

Labored breathing, headaches, eventual unconsciousness, and suffocation

## CO2 SAFETY CODES AND STANDARDS



### International Fire Code

5,000 ppm CO2 Concentration or Fault Indicator - Awareness Indication



### NFPA 55 and OSHA

5,000 ppm (0.5%) 8-hour Time Weighted Average (TWA) - Indication



### NBIC Part 1 and Supplement 3

Pre-set 15,000 ppm (1.5%) and 30,000ppm (3.0%) High Alarms.  
As noted by the National Board Inspection Code part 1 supplement 3 and short term exposure limit defined by ACGIH and NIOSH.



### OSHA and NIOSH

OSHA and NIOSH for CO2 exposure for workers that is no lower than 5,000ppm TWA for first alarm, 15,000ppm as the half STEL (short term exposure limit).

## HAZARD AREAS



Confined Spaces or Low Lying Areas



Areas Where CO2 is Transported or Used

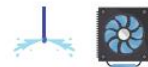

Areas Where CO2 is Vented and Stored



Areas Where CO2 is Enriched or Implemented



Areas Where CO2 is Filled, Including Adjacent Areas.

## LEARN MORE!



877.678.4259

@ Sales@CO2Meter.com

## Introduction to the RAD-0102-6

Thank you for selecting the RAD-0102-6 CO2 Storage Safety Three Alarm. This monitor is designed to detect Carbon Dioxide levels in the ambient air to protect employees and customers. CO2 monitors are required in most jurisdictions by code. High concentrations of CO2 in confined spaces are dangerous and may lead to health problems ranging from headaches and fatigue to asphyxiation and death. This monitor has 3 audible and visual alarm levels with relays that are triggered at 5,000 ppm TWA, 5,000 ppm, and 30,000 ppm and can control a ventilation fan or signal the fire panel to send an alarm to the fire department or monitoring company. These standards meet IFC, NFPA, and NBIC requirements for monitoring.



### Key Features

- (3) Safety alarms (Audible and Visible)
- NDIR sensor with extended lifespan
- Push button configuration
- 4-20mA output for communication with **Building Maintenance Systems**
- (2) Dry contact relays triggered by each alarm level (NO or NC)
- (1) Dry contact relays triggered power fault indicator (NO or NC)
- Back-up battery connection available
- Easy calibration function
- Barometric pressure compensation
- Temperature compensation
- Alarm latching function
- Strobe accessories available: [CM-1027 \(Click HERE\)](#)

## Display



## Icons and Symbols

Icon/Symbol	Description
<b>1215 PPM</b>	CO2 Level Icon: Displays the live ambient carbon dioxide levels of the area being monitored. Updates every 2 seconds.
<b>DIAG</b>	Technician diagnostics feature. Communication test.
<b>AL1</b>	1 <sup>st</sup> Alarm Icon: 1 <sup>st</sup> alarm. (5,000TWA) LED Flash Frequency : 2Hz
<b>AL2</b>	2 <sup>nd</sup> Alarm Icon: Configurable 2 <sup>nd</sup> alarm. (Default 5000ppm or 0.5% CO2) LED Flash Frequency : 4Hz Buzzer Frequency: 4Hz
<b>AL3</b>	3 <sup>rd</sup> Alarm Icon: Configurable 3 <sup>rd</sup> alarm. (Default 30,000ppm or 3% CO2) LED Flash Frequency : 6Hz Buzzer Frequency: 6Hz
<b>CALI</b>	Calibration Icon: (See page 15 for calibration instructions)
<b>RCFS</b>	Reset Factory Setting Icon: (See page 16 for reset instructions)
<b>HI</b>	High CO2 Icon: Indicated CO2 levels greater than 5%
	Alarm Icon: Appears after AL1 is triggered and will remain on display while the monitor is in alarming state
	Ventilation Icon: CO2 Levels exceed AL2 and Relay2 has been triggered.

## Specifications

<b>CO2 Specification</b>	
Measurement Range	0 - 50,000ppm (5%) display
Display Resolution	10ppm at 0~10,000ppm; 0.01% at 1-5%
Accuracy	+/-200ppm or +/-10% reading
Pressure Dependence	Auto pressure compensation, built in barometer. (50 to 110 kPa)
Response Time	CO2: <2min by 90%
CO2 AL1 (TWA )	5000TWA
CO2 AL2	5000ppm Default (5000ppm, 1.0%, 1.5%, 2.0%, 2.5%, 3.0%.)
CO2 AL3	3.0% Default (2.0%, 2.5%, 3.0%, 3.5%, 4.0%)
Sound Alarm	80db@10cm
Warm-Up Time	<60 seconds at 22°C
<b>Monitor Specification</b>	
Power Input	9~32VDC (12~24VDC recommended), 2A.
Backup Battery	6VDC (5.4V~7.0V), recommended capacity is 12AH
Relay 1	Dry contact relay controlled by Power Fault (2Amp) (NO or NC)
Relay 2	Dry contact relay controlled by AL2 (2Amp) (NO or NC)
Relay 3	Dry contact relay controlled by AL3 (2Amp) (NO or NC)
4-20mA CO2	CO2: Range 0-50,000ppm
4-20mA TEMP	Temp: Range 32 to 122° F (0-50°C)
Dimensions	8.25-inch x 7.8-inch x 3-inch
Weight	1.5lbs (Monitor only)
Ingress Protection	IP54
<b>Temperature Specification:</b>	
Temperature Range	32°F to 122°F (0°C to 50°C)
Display Resolution	0.1°F (0.1°C)
Display Options	°C/°F
Accuracy	Reading represents device temperature (NOT environment)
Response Time	20-30 minutes (Enclosure must equalize with environment)
<b>Operating Conditions:</b>	
Temperature	32°F to 122°F (0°C to 50°C)
Humidity Range	0 ~ 95% RH non-condensing
<b>Storage Conditions:</b>	
Storage Temperature	-4°F to 140°F (-20°C to 60 °C)

## Layout

### SEU (Sensor Unit)

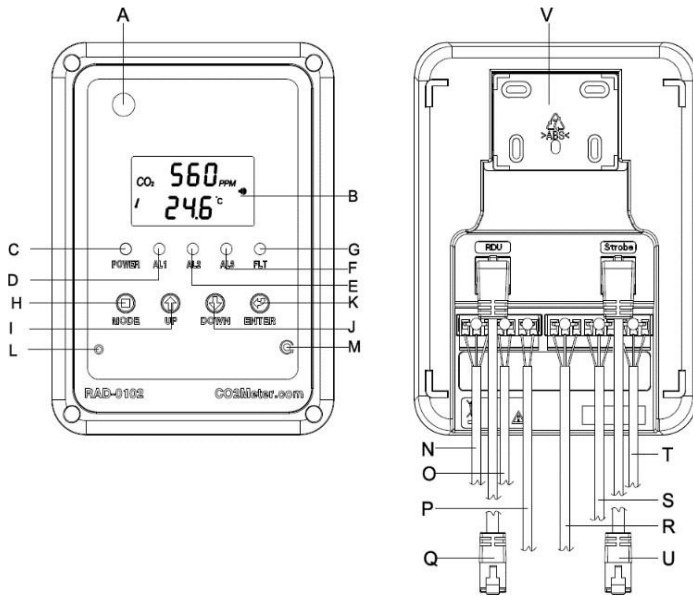

- A. CO2 Sensor
- B. LCD display
- C. Power (Green LED)
- D. AL1 (Red 1 LED)
- E. AL2 (Red 2 LED)
- F. AL3 (Red 3 LED)
- G. Fault (Yellow LED)
- H. Mode Button
- I. UP Button
- J. Down Button
- K. Enter Button
- L. Buzzer
- M. Reset Button
- N. 4-20mA Output
- O. Battery
- P. DC Power Supply
- Q. RDU Cable (RJ45)
- R. Relay 3 (AL3)
- S. Relay 2 (AL2)
- T. Relay 1 (AL1)
- U. Strobe Cable (RJ45)
- V. Panel Holder

### RDU (Remote Display Unit)

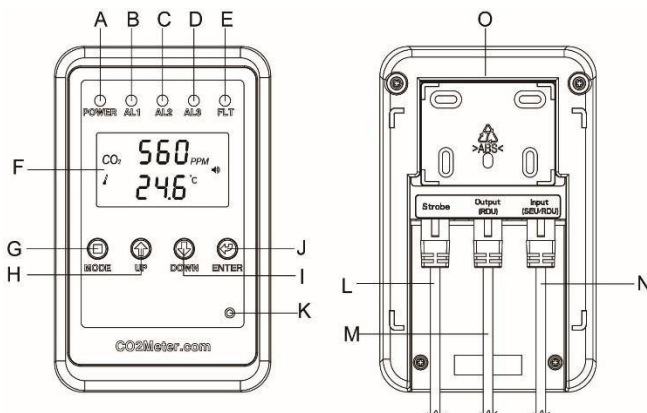

- A. Power (Green LED)
- B. AL1 (Red 1 LED)
- C. AL2 (Red 2 LED)
- D. AL3 (Red 3 LED)
- E. Fault (Yellow LED)
- F. LCD display
- G. Mode Button
- H. UP Button
- I. Down Button
- J. Enter Button
- K. Buzzer
- L. Strobe Cable (RJ45)
- M. Output Cable (RJ45)
- N. Input Cable (RJ45)
- O. Panel Holder

## SEU (Sensor Unit)

The SEU (Sensor Unit) should be mounted in a room where CO<sub>2</sub> is likely to accumulate, this can be caused by a leak or use of the gas in production applications.

The large LCD displays the ambient CO<sub>2</sub> concentration.

The SEU Display functions:

- "DIAG" function executes communication tests between the SEU and RDU.
- "AL1" is a fixed 5000ppm TWA.
- "AL2" has CO<sub>2</sub> level of 5000ppm, 1.0%, 1.5%, 2.0%, 2.5%, 3.0%. (AL2 default 5000ppm)
- "AL3" has CO<sub>2</sub> levels of: 2.0%, 2.5%, 3.0%, 3.5%, 4.0%. (AL3 default is 3.0%)
- "CALI" function allows the user to perform calibration, when necessary.

"RCFS" function allows the user to reset the unit to the original factory settings.

When the RAD-0102-6 detects a CO<sub>2</sub> value that exceeds 5,000ppm, the AL1 (Red 1 LED) will blink, and Relay 1 will be triggered.

When the CO<sub>2</sub> TWA value drops below 5000ppm (TWA), AL1 (Red1 LED) will stop blinking and Relay 1 will be inactive.

When the RAD-0102-6 detects a CO<sub>2</sub> value that exceeds the AL2 CO<sub>2</sub> level, AL2 (Red 2 LED) will blink, the buzzer will sound, and Relay 2 will be triggered.

When the CO<sub>2</sub> value drops below the AL2 CO<sub>2</sub> level, AL2 (Red 2 LED) will stop blinking, the buzzer will stop, and Relay 2 will be inactive.

If the CO<sub>2</sub> concentration continues to rise and exceeds the AL3 CO<sub>2</sub> level, AL2 (Red 2 LED) and AL3 (Red 3 LED) will flash together. The tempo of the flashing and buzzer will increase. RAD-0102-6 will latch after this event. When the CO<sub>2</sub> value drops below the AL3 CO<sub>2</sub> level and then below the AL2 CO<sub>2</sub> level, the flashing and buzzer will stop, but the Fault LED will remain flashing.

The RAD-0102-6 must be reset, by means of the reset button of RAD-0102-6 (See item M in layout) or power cycle the unit.

The Power (Green LED) will light continuously when the power is normally supplied. If the device is powered by a battery, the Power (Green LED) will flash, and battery indicator will appear and change with the battery voltage.

If the communication cable between the SEU & RDU is not connected securely, the communication cable is loose or disconnected from the (RJ45) connectors, the fault LED of SEU will blink as a reminder for the user to reconnect the cable. If the communication cable is inserted into the wrong port on RDU, after about one minute, the "Er7" will flash on the RDU LCD. Please plug the cables into the correct ports on RDU and the unit will work normally.

### **RDU (Remote Display Unit)**

The RDU displays the data from the SEU and provides visual and audible indication that the SEU is in alarm status. The RDU is NOT an external/second sensor. The RDU is connected to the SEU with a CAT5 cable. A 25-foot CAT5 cable is provided. Users can source additional cable lengths as needed. The RDU should be placed where it can be conveniently observed (eye level) before entering the room/space.

The "DIAG" function can test the communication between the SEU and RDU (see page 16). Resetting the RAD-0102-6 CO2 Monitor is only available from SEU.

### **Strobes**

The RAD-0102-6 can be equipped with strobes for additional visual alarms. Using CAT5 cables, connect the strobes to the correct RJ45 ports on the SEU and RDU. If CO2 levels exceed AL2, the strobe will flash. If the CO2 level exceeds AL3, the strobe tempo increases. Please visit [www.CO2Meter.com](http://www.CO2Meter.com) for strobe package. Part Number: CM-1027.

### **Power**

The RAD-0102-6 comes pre-wired with a 12V power supply that plugs in to a wall outlet. The 12V power supply can be removed and 24V DC can be wired directly to the device through the terminal block. Please use a 24V DC power converter to properly convert your AC power source.

## Installation

### Step-by-Step Installation Instructions:

1. Choose a suitable location to install the SEU. Fix the panel holder on the wall with the four screws. Install the SEU 12 inches from floor and close to the CO2 source.
2. Put the SEU on the panel holder, making sure that they are connected tightly.
3. Fix another panel holder in a suitable location outside the monitored space at eye level. Place the RDU onto panel holder and stick the warning signs next to RDU.
4. Route the 25-foot CAT5 cable between the SEU and RDU. CAT5 cable can be run through the wall/conduit or fixed to the wall using cable clips. Plug the CAT5 cable into the designated ports. Communication between the SEU and RDU is complete.
5. The RAD-0102-6 has 3 relay outputs connected to the programmed alarm settings. All relays are normally open/closed dry contacts. Any of the relays can be used to control an external device (fan, HVAC system, etc.) or can be wired to the fire alarm panel directly. The relays will trigger when the CO2 concentration exceeds the programmed alarm level.
6. When the power has been connected, The SEU and the RDU will begin to work.
7. Please use the "DIAG" function to verify the communication between SEU and RDU, the five LED's will blink, and buzzer will sound on SEU & RDU, after that the communication is ready. The units will display the same information.

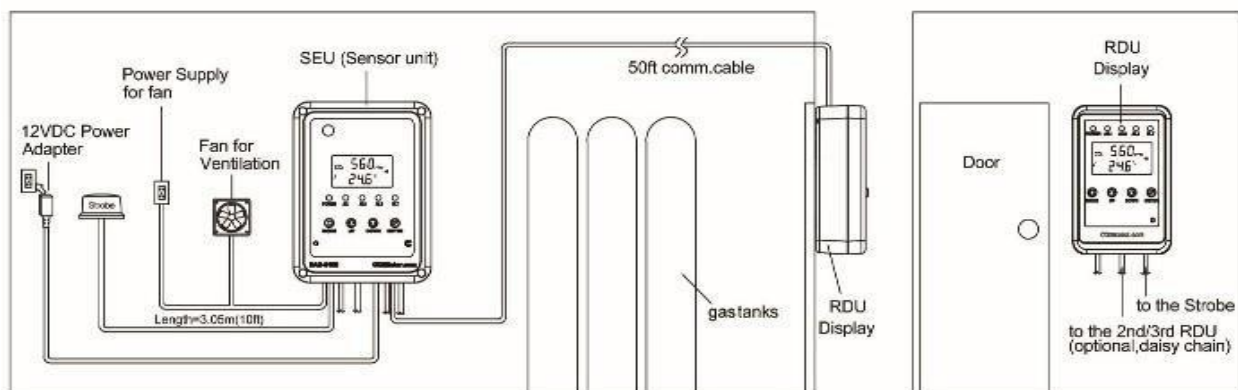

## Operation

### Start-up

Verify that the RAD-0102-6 is properly wired, and 12-24VDC power is being supplied to the correct pin positions in the mating connector (see page 10). Check all wiring connections before powering. After power-up, the monitor provides accurate CO<sub>2</sub> measurements after a 5 second warm up.

### Quick Test the System

- 1) Apply 5% Carbon Dioxide to the sensor port on the device. Check that all alarms trigger and the display will eventually read HI.
- 2) Al1 will sound.
- 3) Al2 will sound and trigger Relay 2.
- 4) Al3 will sound and trigger Relay 3.
- 5) The device will sound and flash audible and visual alarms.
- 6) If a Strobe Siren is connected, it will sound and flash.
- 7) Remove gas supply.

\*\*\*Allow 5 minutes for the device to come out of the HI CO<sub>2</sub> alarm status.\*\*\*

### Unlocking/Locking Settings

- 1) Press Up & Enter button for 10 seconds.
- 2) Press Mode until Aln is displayed.
- 3) Use Up/Down arrow to change lock to unlock.
- 4) Press Enter to save.

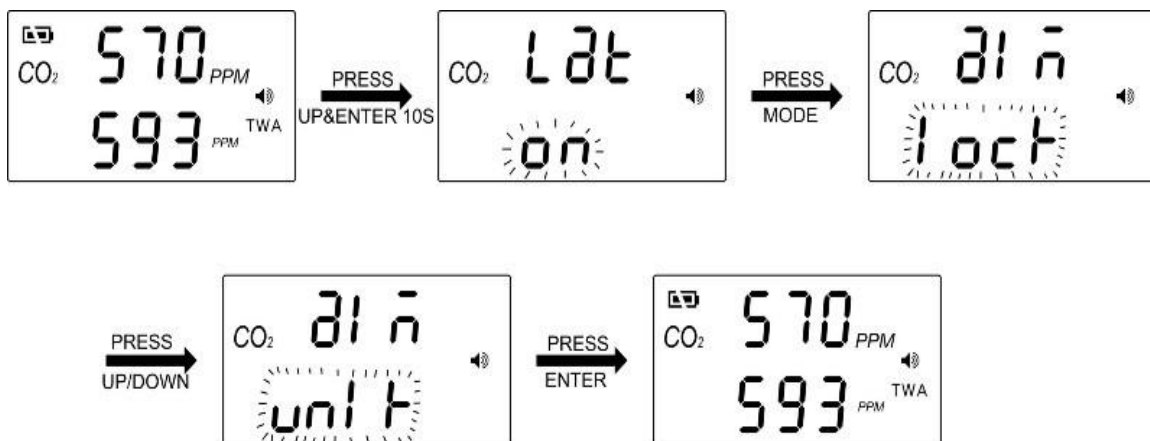

## Configuring AL1

AL1 is hard set to 5000TWA.

## Configuring AL2 (Default 5000 ppm)

1. Verify device is unlocked. (See page 12)
2. Press Mode until the "AL2" & "CO2" icon flash
3. Press Enter to select alarm 2. AL2 level will now flash.
4. Use Up/Down arrow to select new alarm level.
5. Press Enter to confirm.

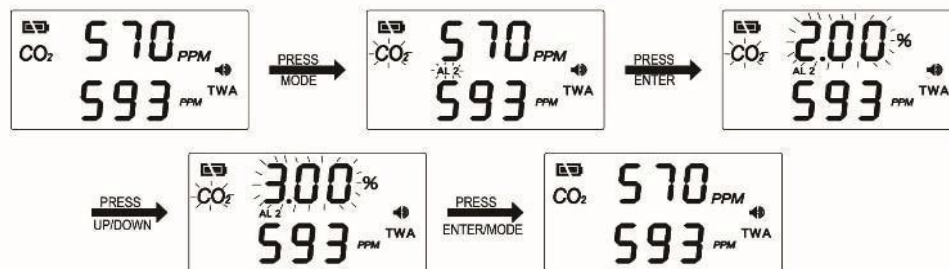

## Configuring AL3 (Default 3.0%)

1. Verify device is unlocked. (See page 12)
2. Press Mode until the "AL3" & "CO2" icon flash.
3. Press Enter to select alarm 3. AL3 level will now flash.
4. Use Up/Down arrow to select new alarm level.
5. Press Enter to confirm.

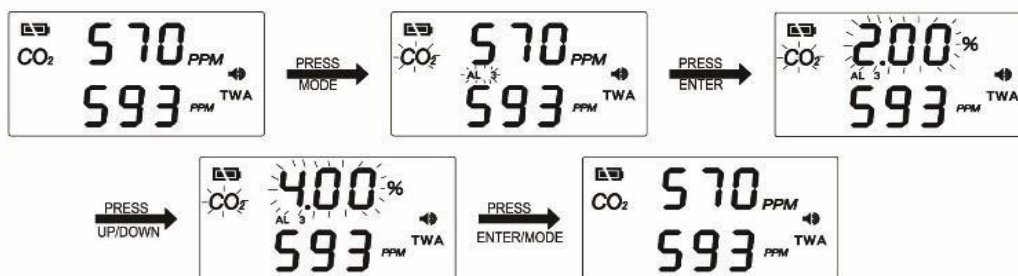

## Latch ON/OFF (Default Latch is set to OFF)

1. Press and hold Up & Enter button for 10 seconds.
2. Change to Advance Mode by pressing Mode, and choose Lat Mode.
3. Press Up/Down to set Latch Mode On or Off.
4. Press Enter to Save.

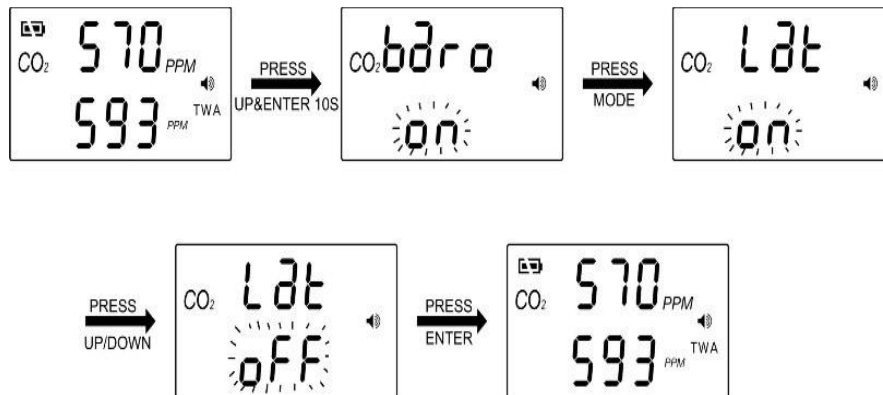

## Reset Latch

### Reset from SEU

1. Press the recessed reset button on the lower right-hand corner of the SEU.

### Reset from RDU

1. Press Mode 2 times , the display on RDU will show "Clear latch"

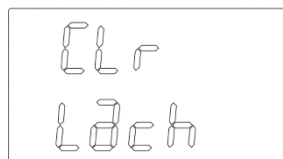

2. Then press Enter key, user can select Yes or No by Up/ Down key
3. Select Yes ,then press Enter , RDU will reset latch
4. Select No, then press enter , RDU will not rest latch

## Baro ON/OFF (Default Baro is set to ON)

1. Press and hold Up & Enter button for 10 seconds.
2. Press Mode, and choose Baro Mode.
3. Press Up/Down to set Baro Mode On/Off.
4. Press Enter to Save.

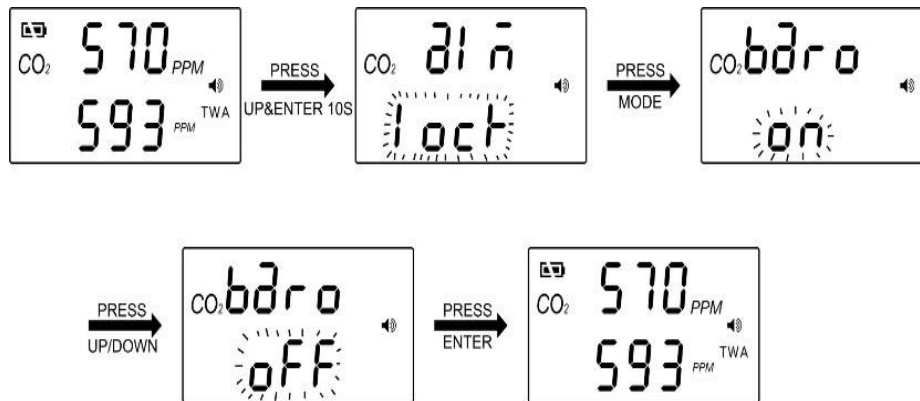

## Calibration

1. Flow 100% Pure Nitrogen (N<sub>2</sub>) (0% CO<sub>2</sub>) into CO<sub>2</sub> Sensor Entry (Item A in Layout on page 8). Wait 3-5 minutes before starting calibration, then execute the "ZErO" calibration.

(Continue to flow calibration gas throughout entire process)

2. Press Mode until CALI is flashing in small print under the CO<sub>2</sub> reading.
3. Press Enter to view the calibration settings.
4. "ZErO" and "CO<sub>2</sub>" will be flashing.
5. Press Enter again to begin the calibration. "CALIBRATING" will begin flashing.

(Continue to flow N<sub>2</sub> throughout the entire calibration)

6. After approximately 3 minutes, "PASS" or "FAIL" will be displayed.
7. If "PASS" press Enter to save.
8. If "FAIL" repeat the process.
9. If "FAIL" more than twice, contact CO<sub>2</sub>Meter technical support.

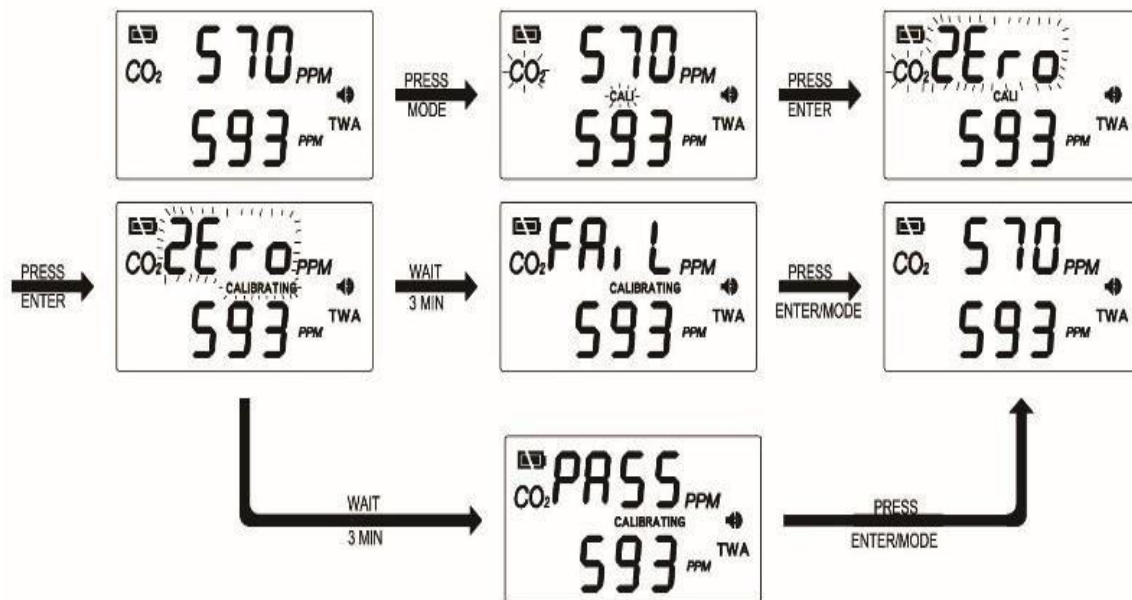

## System Test

1. Press Mode until the “DIAG” icon flashes.
2. Press Enter, the five LEDs will blink, and the buzzer will sound.



## Factory Reset

1. Press Mode until the “RcFs” icon flashes.
2. Press Enter Up/Down to choose either “Yes” or “No”.
3. Press Enter again to save the setting or press Mode to quit the setting.

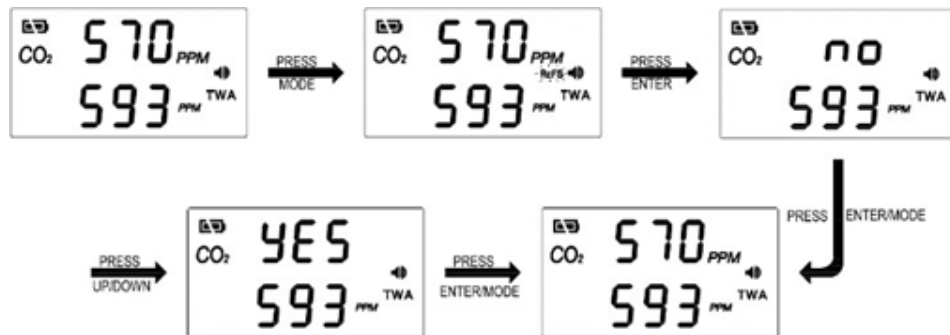

## Maintenance

The RAD-0102-6 is a low maintenance safety monitor that requires little maintenance after initial installation. It is recommended to calibrate the internal NDIR CO2 Sensor every two to three years. This calibration can be completed in the field, or the monitor can be returned to CO2Meter to perform the calibration. A calibration certificate will be provided with every calibration service. Be sure to ask a CO2Meter technician for more information.

## Error Codes

No	LCD Fault Icon	Description (of the fault)	SEU Indication	RDU Indication	Suggested Actions
1	Er3	Ambient temperature exceeded the temperature range 0°C to 50°C (32°F to 122°F)	“Er3” flash, Fault LED blink	“Er3” flash, Fault LED blink	This error will disappear when the temperature returns to the range between 0°C and 50°C (32°F to 122°F)
2	Er5	EEPROM System Problem	“Er5” flash, Fault LED blink	“Er5” flash, Fault LED blink	Power on again or press reset button, if the “Er5” always appear, please contact CO2Meter.
3	Er7	Internal Data Transmission Error	Flash, Fault LED blink,	Flash, Fault LED Blink	Check the RJ45 plug is connected into the INPUT port of RDU.  Press reset button on SEU or power cycle the unit

## Warranty

CO2Meter warrants the products to be substantially free of defects in workmanship and materials when used for their intended purposes for a period of either one (1) year or ninety (90) days from the date of shipment of the applicable products as specified for each product on the individual product pages located at [www.co2meter.com](http://www.co2meter.com) (the "Manufacturer's Limited Warranty"). No employee or representative of CO2Meter may alter the terms of the Manufacturer's Limited Warranty verbally or in writing.

To take advantage of the Manufacturer's Limited Warranty, the product must be returned to us at your expense. If after examination, we determine that the product is defective, CO2Meter at its election will repair or replace the defective product. The foregoing is the customer's exclusive remedy in the event of a valid warranty claim.

Notwithstanding anything contained herein, the Manufacturer's Limited Warranty shall not apply to: (i) any product that has been customized, altered, or repaired by any person not authorized to do so by CO2Meter; or (ii) any product that has been subject to misuse, neglect, or accidental damage. This warranty does not apply to calibration of any product.

In the event of an alleged warranty claim, you agree to contact us to request a return authorization prior to returning any products to us. We will only honor valid warranty claims of which we have been given notice prior to the expiration of the applicable limited warranty period. You agree to comply with all commercially reasonable rules and policies governing warranty claims which we may institute from time to time. Such rules and policies may be located at [www.co2meter.com/pages/faq#warranty](http://www.co2meter.com/pages/faq#warranty).

If you return a product to us, and we determine in our reasonable discretion that it falls within an exception to the Manufacturer's Limited Warranty as described herein, we will have no obligation to you other than to return the product(s) at your sole cost and expense.

It is our customer(s) responsibility to share your application with the CO2Meter sales team so they can help identify any potential issues your application may cause with our devices. Important information to share will be: expected CO2 concentration, temperature, humidity, and any other particles or gases in your application. Applications with interfering gases can damage our sensors and devices. Those applications with high humidity can damage the electronics and the CO2 sensors beyond repair.

## Product Returns

If any Product fails under normal use, you may return it to us, by first submitting a customer case support ticket (submission here). Policies and procedures for returns and refunds related to the same are located at [www.co2meter.com/pages/faq](http://www.co2meter.com/pages/faq).

All returns for refund after thirty (30) days from shipment of the applicable product will incur a 25% re-stocking fee. No product will be accepted for return or refund after 45 days from shipment.

Non-refundable clause, if a product is refunded, and your purchase included a calibration certificate charge, due to the calibration being a service, not an actual product item your refund will not include the certification charge in your refund.

## Support

If the User Manual/ Installation guide above does not contain the needed operation, installation or trouble shooting information, please contact CO2Meter at:

[Support@CO2Meter.com](mailto:Support@CO2Meter.com)

## Contact Us

**We are here to help!** For information or technical support, please contact us using the information below. For further guidelines on CO2Meter Terms & Conditions, [click here](#).

✉ [support@co2meter.com](mailto:support@co2meter.com)

☎ (386) 256-4910 (Technical Support)

☎ (386) 872-7665 (Sales)

🌐 [www.CO2Meter.com](http://www.CO2Meter.com)



### CO2Meter

105 Runway Drive  
Ormond Beach, FL  
32174 USA  
877-678-4259  
M-F 8:30am-5pm EDT